

ARKETIPO / SOFAS

AUTO-REVERSE

designed by Giuseppe Vigano' 2013



STRUCTURE: metal.

FRAME UPHOLSTERY: non-deformable polyurethane (D35EM + D70) covered with coupled synthetic lining 6mm.

SEAT CUSHION UPHOLSTERY: outer side in 100% white Gabardine 30/20 cotton cover; filling in 65% goose feathers and 35% duck feathers; inner core in expanded polyurethane (PF35).

BACK CUSHION UPHOLSTERY: outer side in 100% white Gabardine 30/20 cotton cover; filling in 65% goose feathers and 35% duck feathers; inner core in expanded polyurethane (T18/s).

ARMCUSHION PADDING: outer side in white Gabardine 30/20 cotton cover; filling in 100% European goose feathers.

SPRINGING: elastic belts.

SEAT HEIGHT: 43 cm - 48 cm with feet h. 22 cm.

ARM HEIGHT: 60 cm (structure); 74 cm (with arm-side cushion).

FEET: metal, finishes: micaceous brown, titanium or brass, h. 17 cm. **On request feet can be supplied 5 cm higher with an extra charge.**

ZIPS: available in the colours of the zip samples.

ATTENTION: cushions are reversible and they can be covered with different fabrics and/or leathers. The cover of the structure is always in the same fabric or leather of one side of the cushions.

PRICE CALCULATION: To calculate the total price of each unit, please sum the prices of the two columns: A (structure + one side of the cushions) + B (other side of the cushions) even when the unit is completely covered with only one fabric or leather. If the client would like to upholster the unit with more fabrics or leathers of different collections or different colours within the same collection, it is necessary to ask for the price to our sales office.

ONLY COVER PRICE CALCULATION: To calculate the price of the cover, please sum the prices of the two columns: AX (structure + one side of the cushions) + BX (other side of the cushions) even when the unit is completely covered with only one fabric or leather. If the client would like to upholster the unit with more fabrics or leathers of different collections or different colours within the same collection, it is necessary to ask for the price to our sales office.

Sofa, back cushions 95 cm

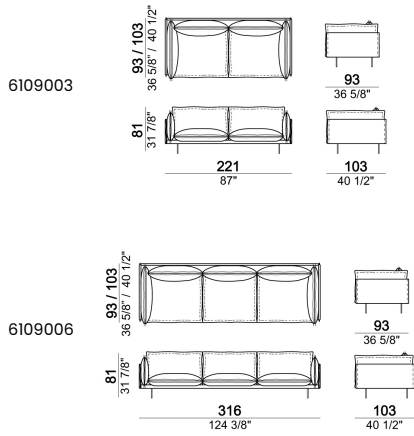

Sofa, back cushions 105 cm

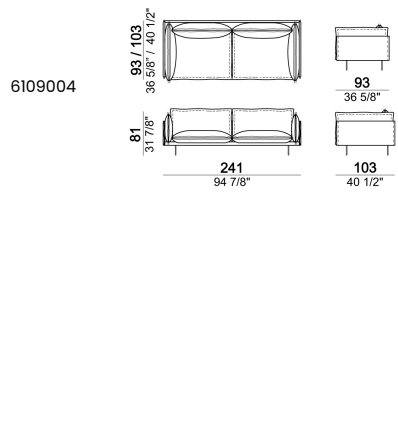

Sofa, back cushions 115 cm

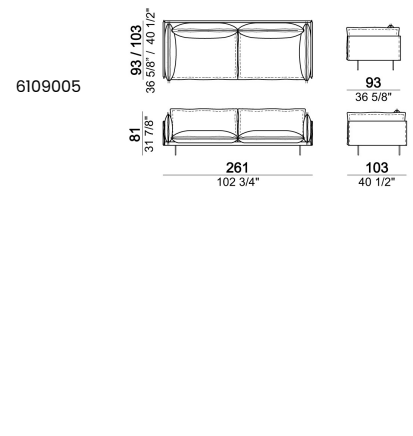

Right or left unit, back cushion 105 cm.

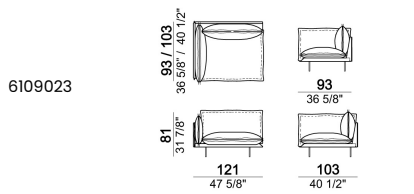

Right or left unit, back cushion 115 cm

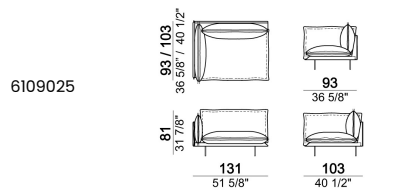

Right or left unit, back cushion 95 cm

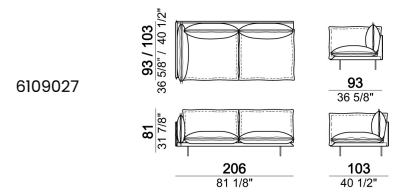

Right or left unit, back cushions 105 cm.

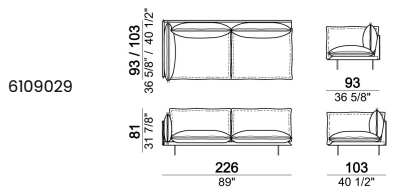

Right or left unit, back cushions 115 cm.

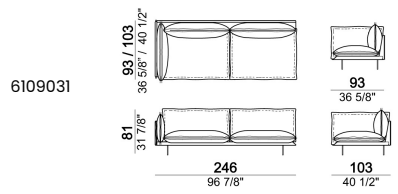

Central unit, back cushion 115 cm.

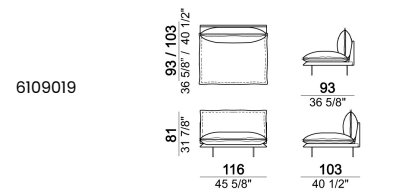

Central unit, back cushions 95 cm.

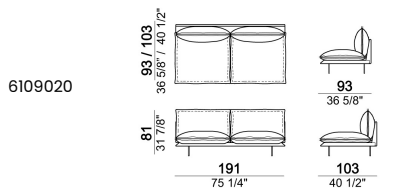

Central unit, back cushions 105 cm.

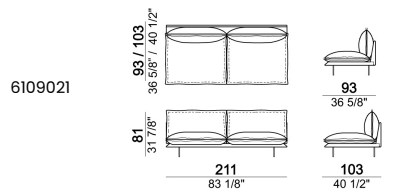

Central unit, back cushions 115 cm.

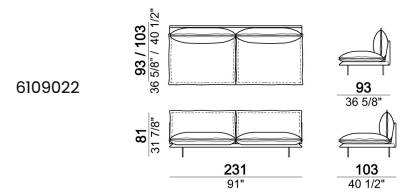

Chaise-longue with right or left short arm, back cushion 95 cm

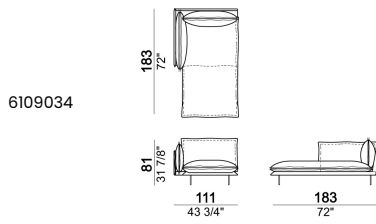

Chaise-longue with right or left short arm, back cushion 105 cm

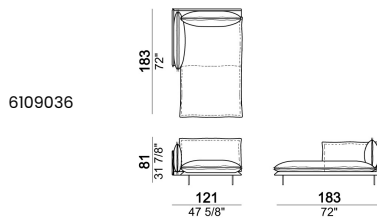

Chaise-longue with right or left short arm, back cushion 115 cm

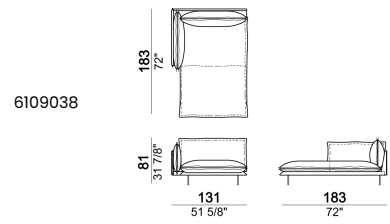

Right or left unit

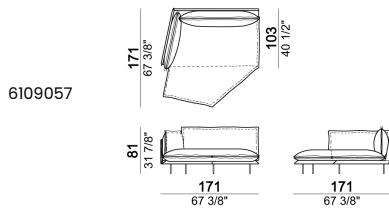

Pouf

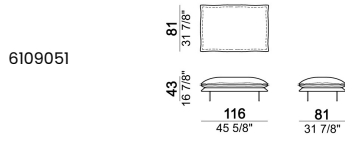
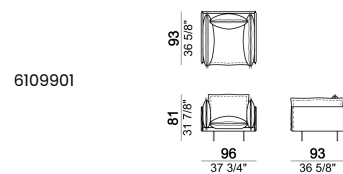
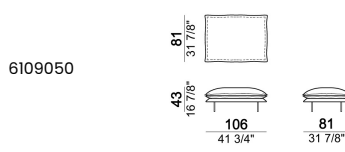

Armchair, back cushion 95 cm

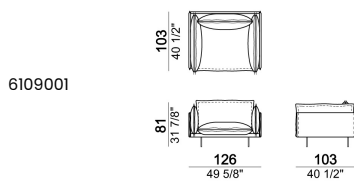

Armchair, back cushion 105 cm

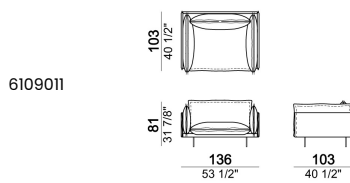

Composition "A" (left unit 226x103 cm + chaise-longue 121x183 cm with right short arm)

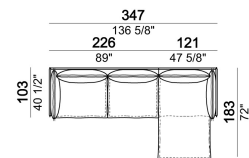

Composition "E" (left unit 226x93 cm + chaise-longue 121x183 cm with right short arm)

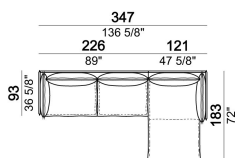

Composition "B" (left unit 226x103 cm + left corner unit 226x103 cm)

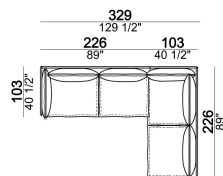

Composition "C" (left unit 246x103 cm + left corner sofa 261x103 cm)

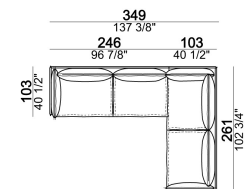

Composition "F" (left unit 246x103 cm + left corner sofa 261x93 cm)

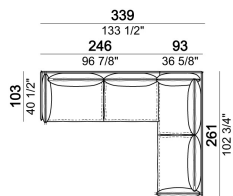

Composition "D" (left unit 226x103 cm + left corner unit 246x103 cm)

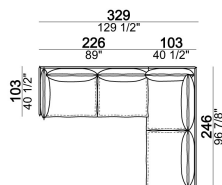

Composition "G" (left unit 206x93 cm + right unit 206x103 cm)

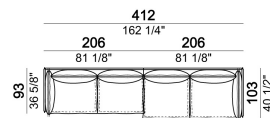

Composition I

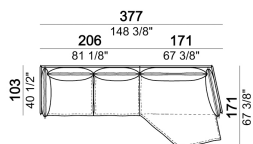

Composition "H" (left unit 226x103 cm+ right unit 171x171 cm)

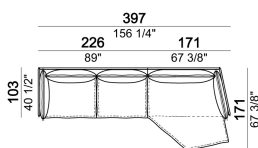

Armccushion

6109052

