

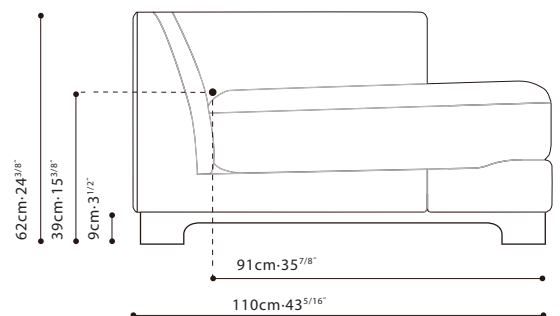

**EASYTIME / FRAME:** Constructed on a solid Birch Wood frame with MDF and plywood reinforcements, paired with cross-woven elastic webbing. The frame is covered with polyurethane foam and fabric lining. **SEAT:** Seat cushions consists of high-resilient polyurethane foam, and is topped with compartmented feather down and polyester fiber. **CUSHIONS:** Back cushions consists of channeled feather down and polyester fiber padding with high-resilient polyurethane foam center insert. Throw cushions C81F0904 and C81F0905 are filled with feather down. All cushions have hidden zipper closing. **LEGS:** Steel legs are finished in black metallic paint and capped with plastic glides. **UPHOLSTERY:** Available in Fabric (removable via Velcro) or Leather (non-removable).

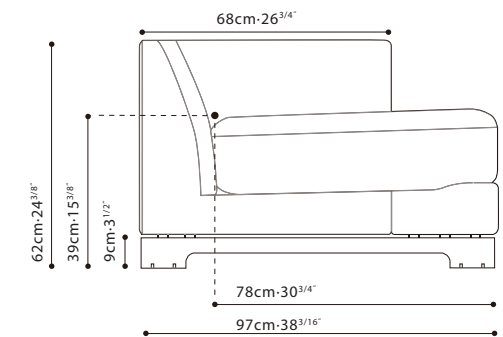
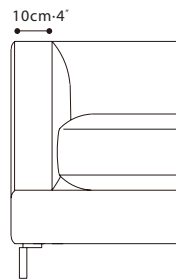

FABRIC VERSION

C01F0901

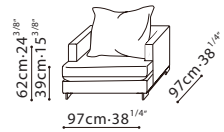

C01F0902

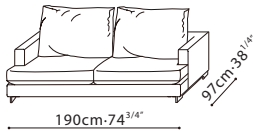

C01F0903

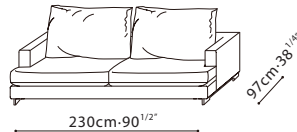

C01F0904

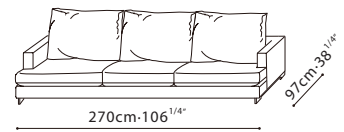

C01F0905

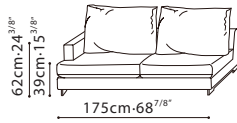

C01F0906

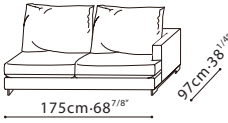

C01F0907

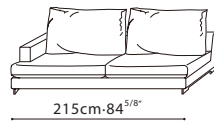

C01F0908

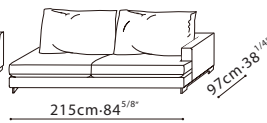

C01F0909



C01F0910

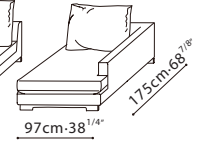

C01F0911

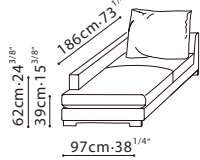

C01F0912

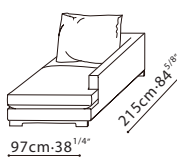

C01F0913

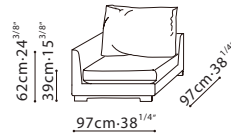

\*If using as corner sofa, please add additional C81F0904 Cushion x1

C01F0929

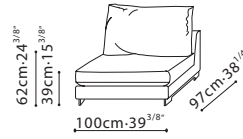

C01F0914



C01F0915

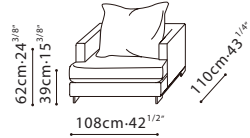

C01F0916



C01F0917

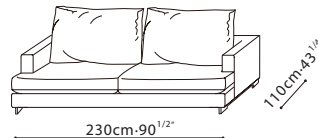

C01F0918

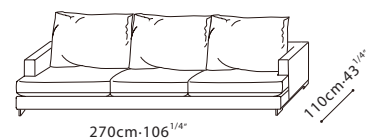

C01F0919

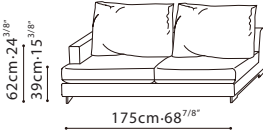

C01F0920

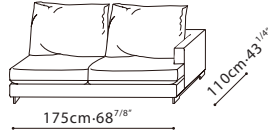

C01F0921

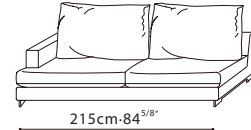

C01F0922

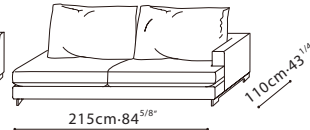

C01F0923

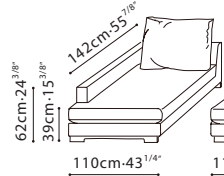

C01F0924

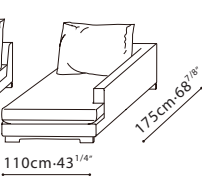

C01F0925

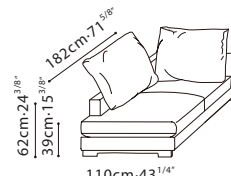

C01F0926

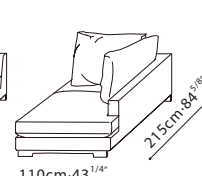

C01F0927

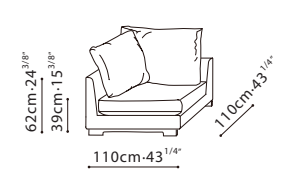

C01F0928

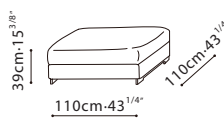

C81F0904



C81F0905



C01F0930



LEATHER VERSION

C01F0901

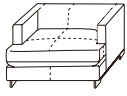

C01F0902

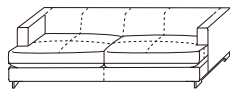

C01F0903

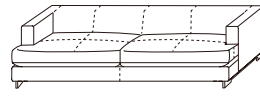

C01F0904

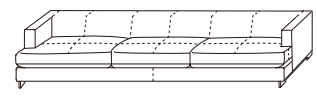

C01F0905

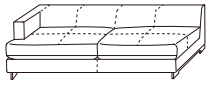

C01F0906

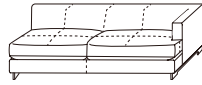

C01F0907

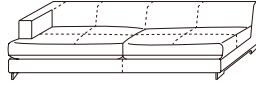

C01F0908

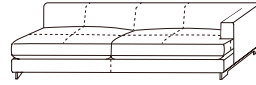

C01F0909

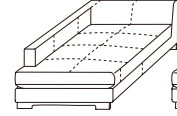

C01F0910

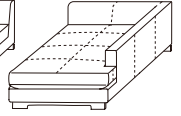

C01F0911

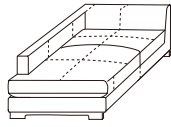

C01F0912

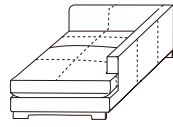

C01F0913



C01F0914

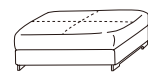

C01F0915

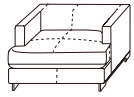

C01F0916

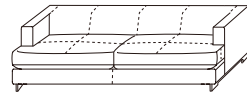

C01F0917

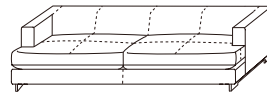

C01F0918

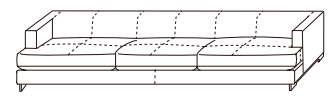

C01F0919

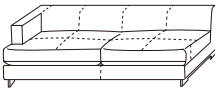

C01F0920

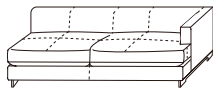

C01F0921

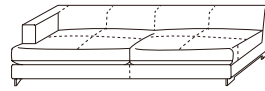

C01F0922

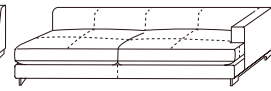

C01F0923

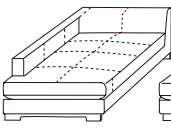

C01F0924

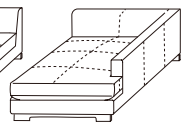

C01F0925

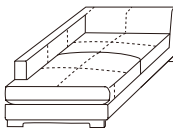

C01F0926

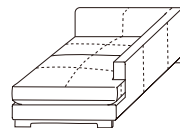

C01F0927



C01F0928

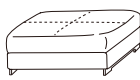

C81F0904



C81F0905



(dotted lines illustrate positioning of stitched seams on leather versions of this sofa)

SAMPLE CONFIGURATION

